

Thermally-Enhanced High Power RF LDMOS FET 10 W, 860 – 960 MHz

Description

The PTF080101S is a 10-watt, internally-matched *GOLDMOS* FET intended for EDGE and CDMA applications in the 860 to 960 MHz band. Thermally-enhanced packaging provides the coolest operation possible. Full gold metallization ensures excellent device lifetime and reliability.



PTF080101S
Package 32259

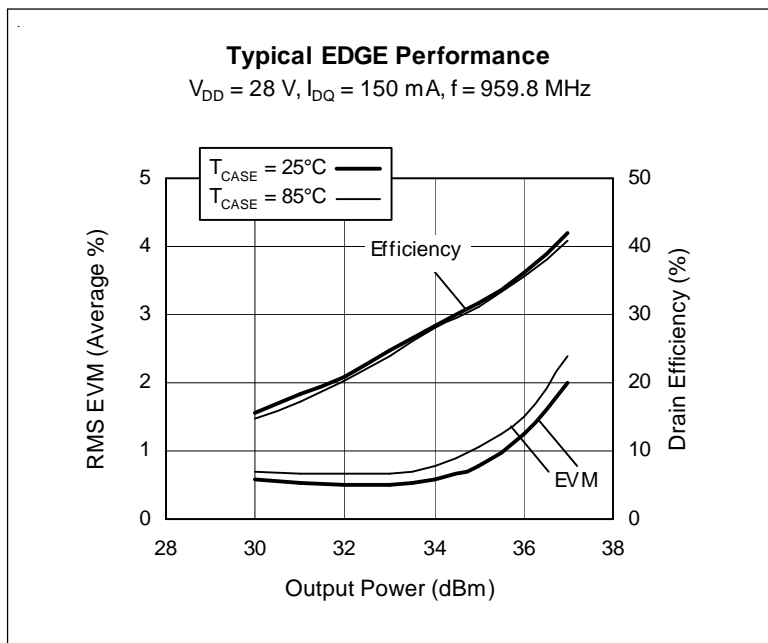

Features

- Thermally-enhanced packaging
- Broadband internal matching
- Typical EDGE performance
 - Average output power = 5 W
 - Gain = 18.5 dB
 - Efficiency = 38%
- Typical CW performance
 - Output power at P-1dB = 13 W
 - Gain = 17.5 dB
 - Efficiency = 55%
- Integrated ESD protection: Human Body Model, Class 1 (minimum)
- Excellent thermal stability
- Low HCI drift
- Capable of handling 10:1 VSWR @ 28 V, 10 W (CW) output power

ESD: Electrostatic discharge sensitive device—observe handling precautions!

RF Characteristics at $T_{CASE} = 25^\circ\text{C}$ unless otherwise indicated

EDGE Measurements (not subject to production test—verified by design/characterization in Infineon test fixture)

$V_{DD} = 28\text{ V}$, $I_{DQ} = 150\text{ mA}$, $P_{OUT} = 5.0\text{ W}$, $f = 959.8\text{ MHz}$

Characteristic	Symbol	Min	Typ	Max	Units
Error Vector Magnitude	EVM (RMS)	—	2.0	—	%
Modulation Spectrum @ 400 kHz	ACPR	—	-61	—	dBc
Modulation Spectrum @ 600 kHz	ACPR	—	-71	—	dBc
Gain	G_{ps}	—	18.5	—	dB
Drain Efficiency	η_D	—	38	—	%

RF Characteristics (cont.)

Two-Tone Measurements (tested in Infineon test fixture)

 $V_{DD} = 28\text{ V}$, $I_{DQ} = 150\text{ mA}$, $P_{OUT} = 10\text{ W PEP}$, $f = 960\text{ MHz}$, tone spacing = 1 MHz

Characteristic	Symbol	Min	Typ	Max	Units
Gain	G_{ps}	18.0	18.5	—	dB
Drain Efficiency	η_D	36.0	38	—	%
Intermodulation Distortion	IMD	—	-32	-30	dBc

DC Characteristics at $T_{CASE} = 25^\circ\text{C}$ unless otherwise indicated

Characteristic	Conditions	Symbol	Min	Typ	Max	Units
Drain-Source Breakdown Voltage	$V_{GS} = 0\text{ V}$, $I_{DS} = 10\ \mu\text{A}$	$V_{(BR)DSS}$	65	—	—	V
Drain Leakage Current	$V_{DS} = 28\text{ V}$, $V_{GS} = 0\text{ V}$	I_{DSS}	—	—	1.0	μA
On-State Resistance	$V_{GS} = 10\text{ V}$, $I_{DS} = 0.1\text{ A}$	$R_{DS(on)}$	—	0.83	—	Ω
Operating Gate Voltage	$V_{DS} = 28\text{ V}$, $I_{DQ} = 150\text{ mA}$	V_{GS}	2.5	3.2	4.0	V
Gate Leakage Current	$V_{GS} = 10\text{ V}$, $V_{DS} = 0\text{ V}$	I_{GSS}	—	—	1.0	μA

Maximum Ratings

Parameter	Symbol	Value	Unit
Drain-Source Voltage	V_{DSS}	65	V
Gate-Source Voltage	V_{GS}	-0.5 to +12	V
Junction Temperature	T_J	200	$^\circ\text{C}$
Total Device Dissipation	P_D	58	W
Above 25°C derate by		0.333	W/ $^\circ\text{C}$
Storage Temperature Range	T_{STG}	-40 to +150	$^\circ\text{C}$
Thermal Resistance ($T_{CASE} = 70^\circ\text{C}$)	$R_{\theta JC}$	3.0	$^\circ\text{C/W}$

Ordering Information

Type	Package Outline	Package Description	Marking
PTF080101S	32259	Thermally-enhanced SMD, single-ended	PTF080101S

Typical Performance (measurements taken in production test fixture)

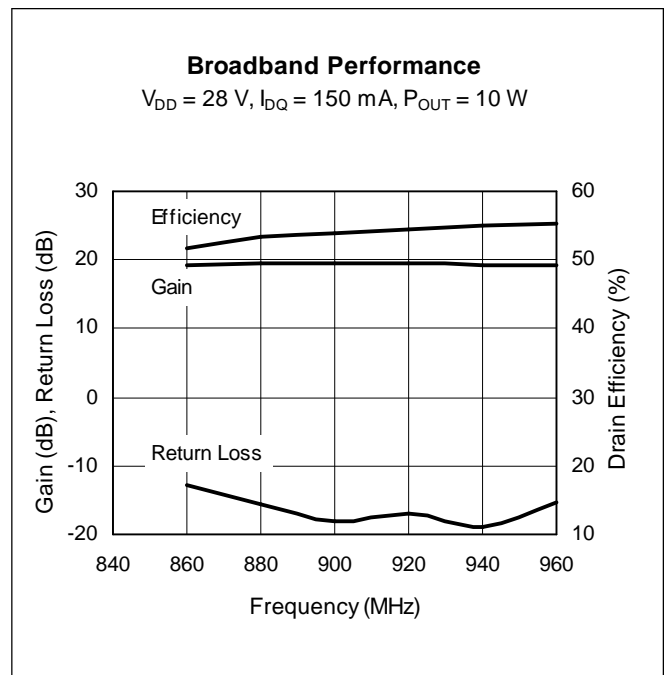
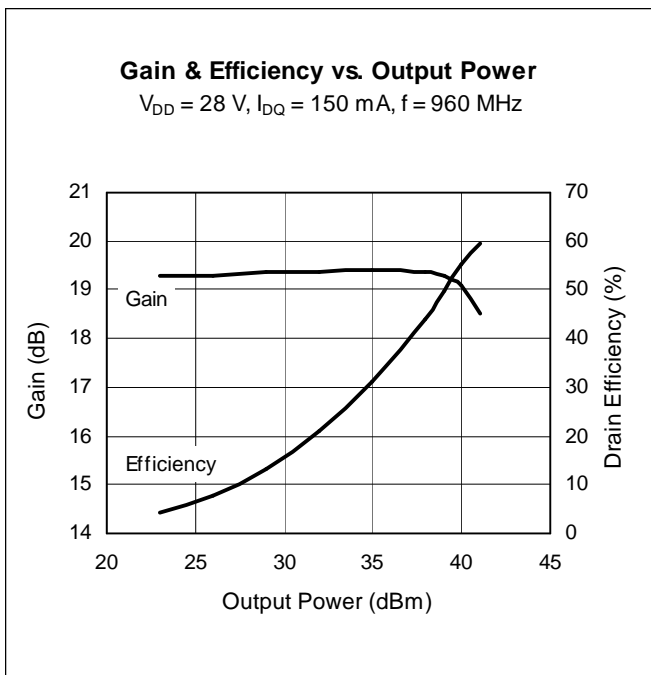
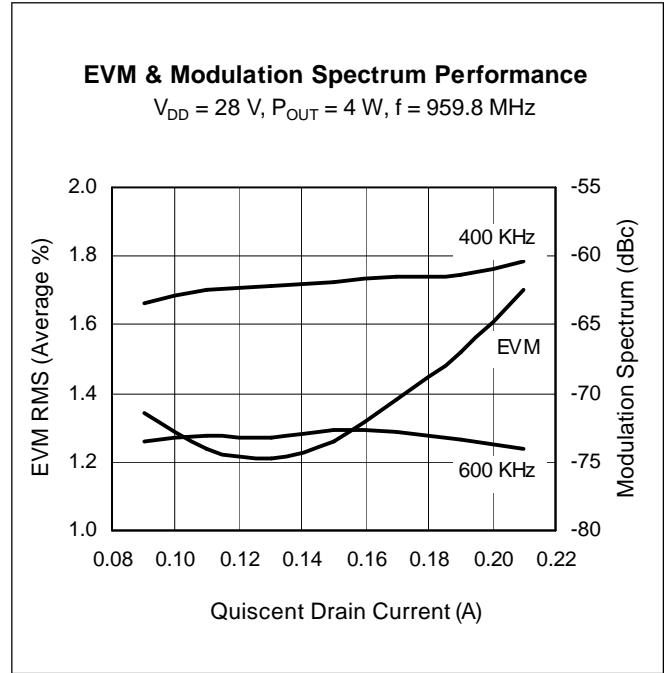
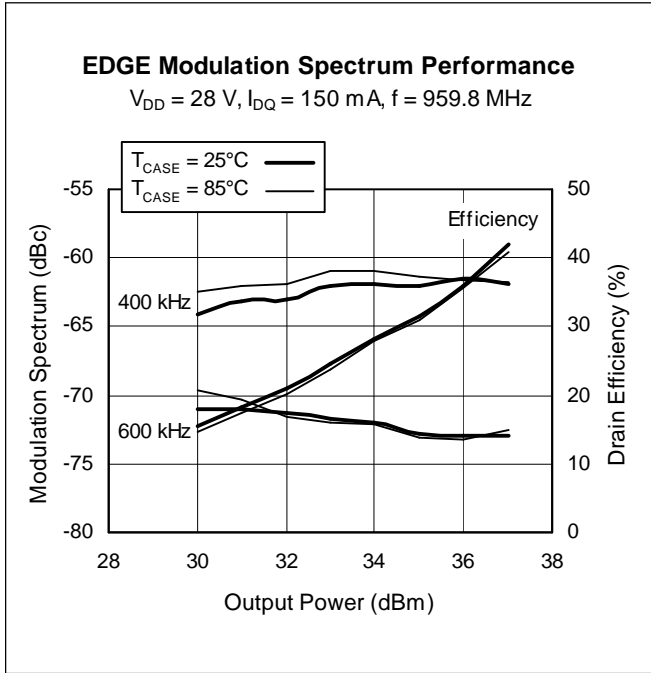

All published data at $T_{CASE} = 25^\circ\text{C}$ unless otherwise indicated

Typical Performance (cont.)

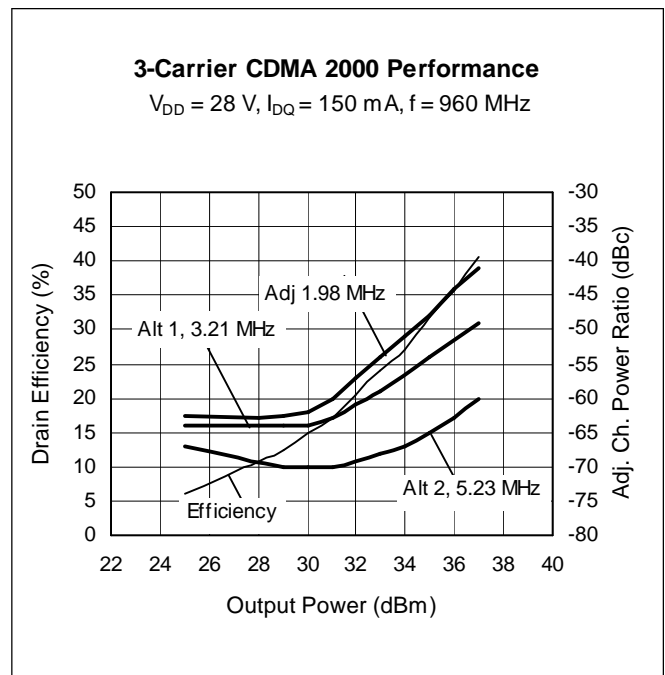
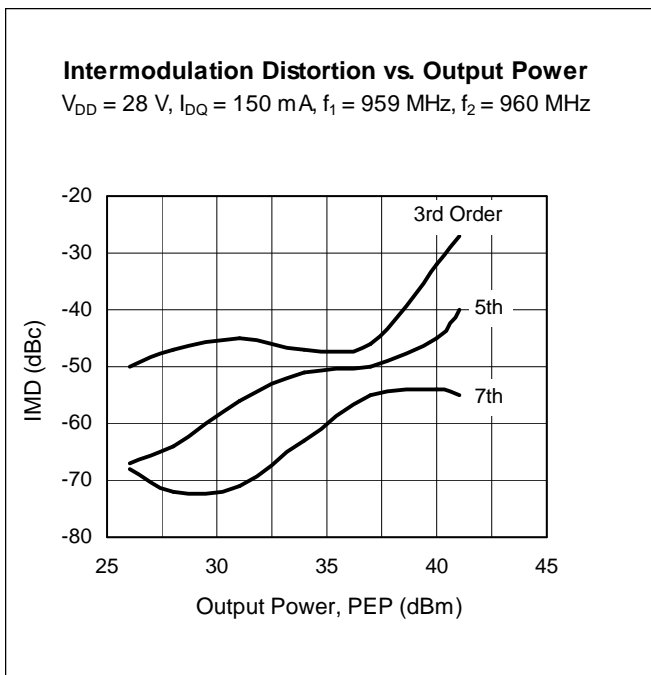
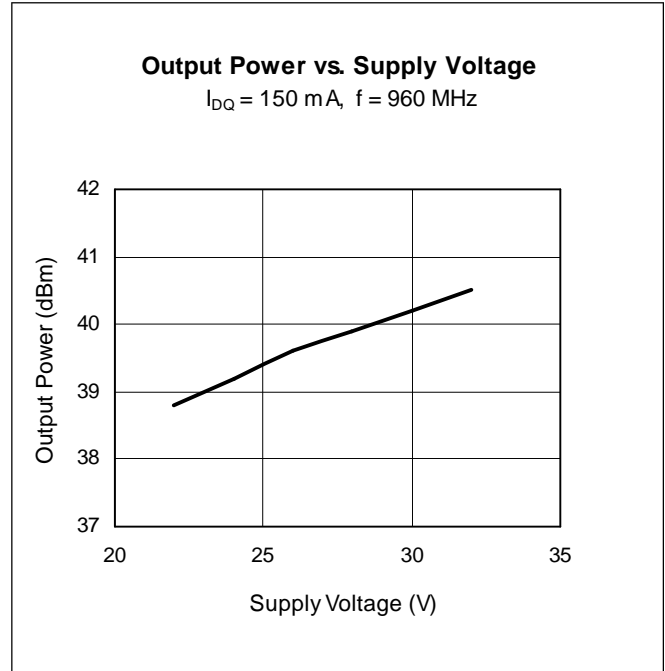
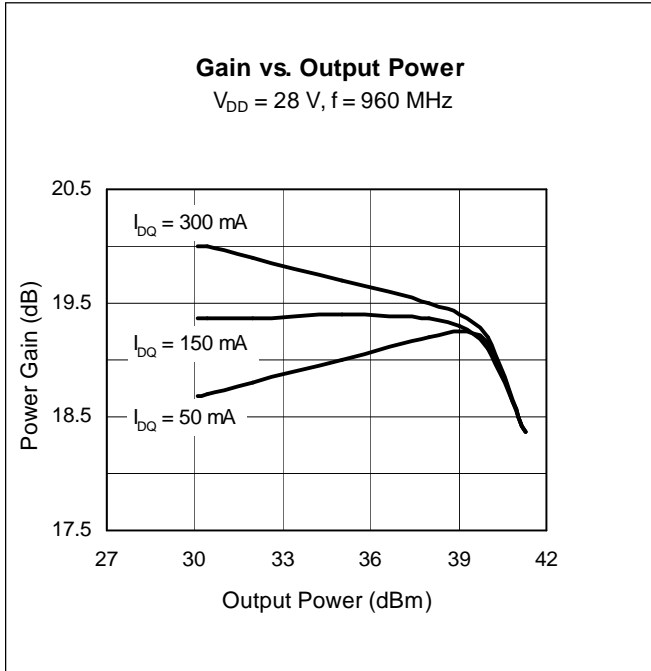

Typical Performance (cont.)

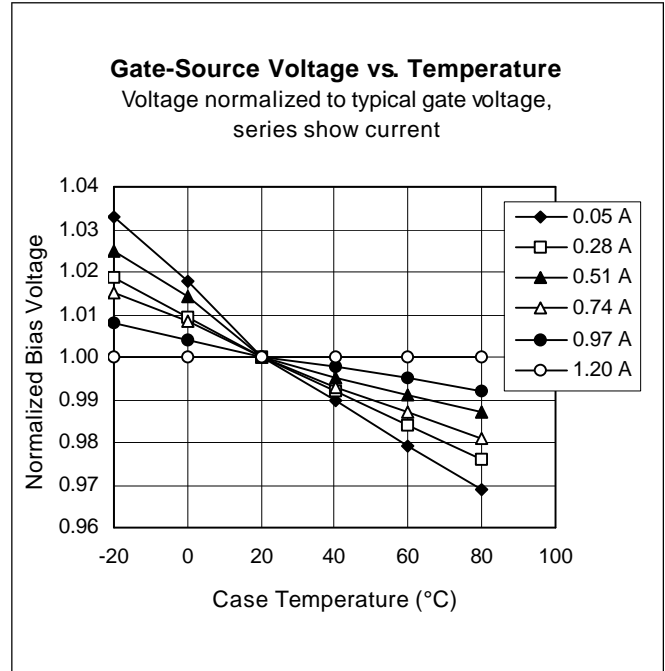
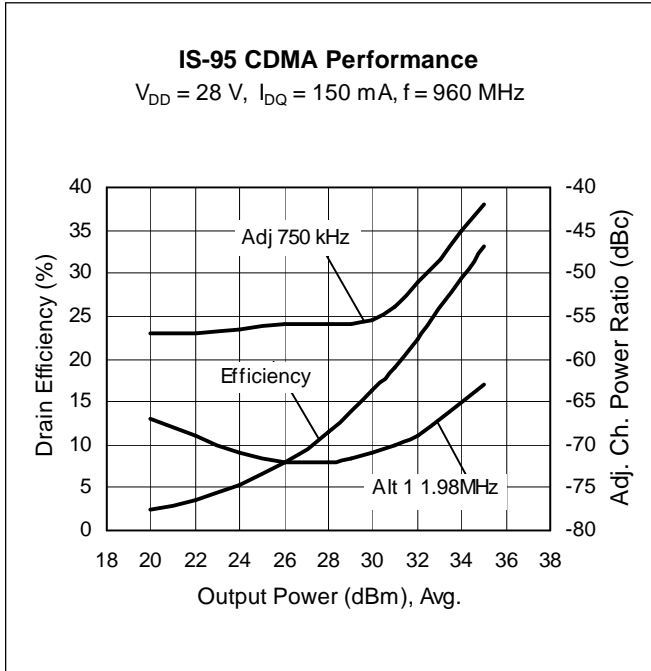

Broadband Circuit Impedance

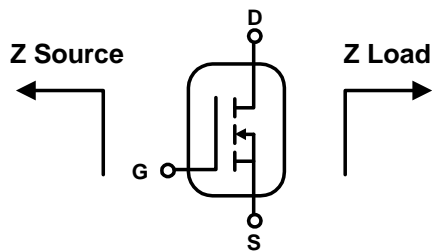

Frequency MHz	Z Source Ω		Z Load Ω	
	R	jX	R	jX
860	1.4	-0.8	10.0	8.0
880	1.3	-0.2	10.0	8.4
900	1.4	0.2	10.0	8.7
920	1.5	0.5	10.0	9.0
940	1.5	1.0	10.1	9.3
960	1.6	1.1	10.3	9.4

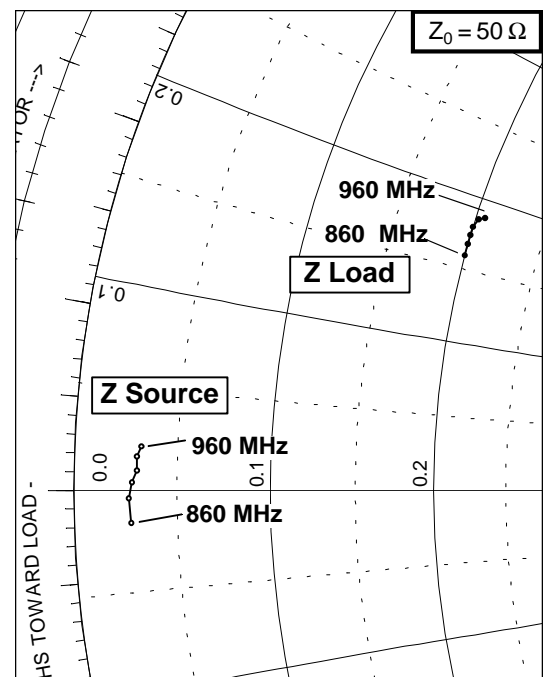

Reference Circuit

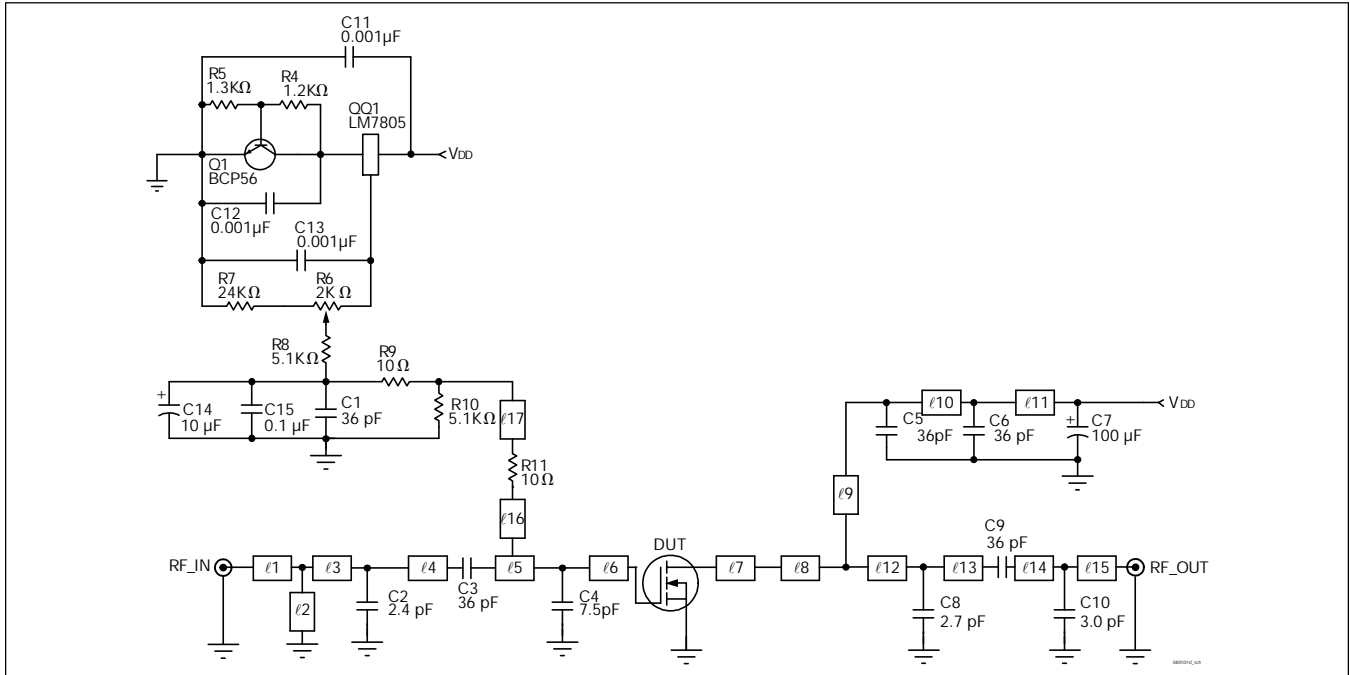

Reference Circuit Schematic for 960 MHz

Circuit Assembly Information

DUT	PTF080101S	LDMOS Transistor
PCB	0.76 mm [.030"] thick, $\epsilon_r = 4.5$	2 oz. copper Rogers TMM4

Microstrip	Electrical Characteristics at 960 MHz*	Dimensions: L x W (mm)	Dimensions: L x W (in.)
l1	0.023 λ , 50.0 Ω	3.68 x 1.27	0.145 x 0.050
l2	0.172 λ , 16.0 Ω	25.40 x 0.64	1.000 x 0.025
l3	0.044 λ , 50.0 Ω	6.99 x 1.27	0.275 x 0.050
l4	0.084 λ , 50.0 Ω	13.46 x 1.27	0.530 x 0.050
l5	0.149 λ , 9.3 Ω	21.46 x 11.94	0.845 x 0.470
l6	0.010 λ , 9.3 Ω	1.52 x 11.94	0.060 x 0.470
l7	0.023 λ , 27.0 Ω	3.56 x 3.25	0.140 x 0.128
l8	0.065 λ , 11.9 Ω	9.53 x 9.02	0.375 x 0.355
l9	0.031 λ , 70.0 Ω	5.08 x 0.64	0.200 x 0.025
l10	0.108 λ , 70.0 Ω	17.78 x 0.64	0.700 x 0.025
l11	0.108 λ , 70.0 Ω	17.78 x 0.64	0.700 x 0.025
l12	0.094 λ , 11.9 Ω	13.72 x 9.02	0.540 x 0.355
l13	0.041 λ , 11.9 Ω	5.97 x 9.02	0.235 x 0.355
l14	0.078 λ , 50.0 Ω	12.45 x 1.27	0.490 x 0.050
l15	0.011 λ , 50.0 Ω	1.78 x 1.27	0.070 x 0.050
l16	0.076 λ , 70.0 Ω	11.18 x 0.64	0.440 x 0.025
l17	0.165 λ , 70.0 Ω	24.38 x 0.64	0.960 x 0.025

*Electrical characteristics are rounded.

Reference Circuit (cont.)

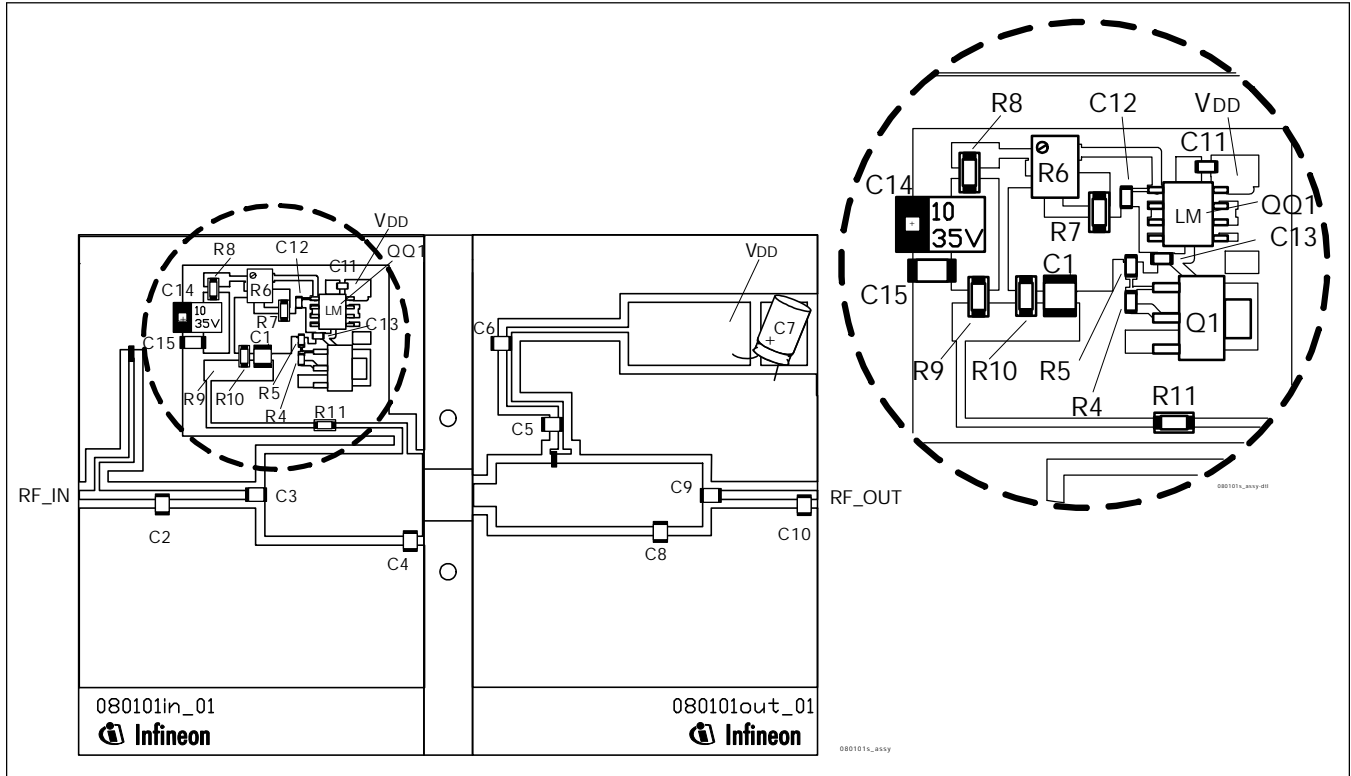

Reference Circuit¹ (not to scale)

Component	Description	Manufacturer	P/N or Comment
C2	Capacitor, 2.4 pF	ATC	100B 2R4
C1, C3, C5, C6, C9	Capacitor, 36 pF	ATC	100B 360
C4	Capacitor, 7.5 pF	ATC	100B 7R5
C7	Capacitor, 100 μ F, 50 V	Digi-Key	P5182-ND
C8	Capacitor, 2.7 pF	ATC	100B 2R7
C10	Capacitor, 3.0 pF	ATC	100B 3R0
C11, C12, C13	Capacitor, 0.001 μ F	Digi-Key	PCC1772CT-ND
C14	Capacitor, 10 μ F, 35 V	Digi-Key	PCS6106TR-ND
C15	Capacitor, 0.1 μ F	Digi-Key	P4525-ND
Q1	Transistor	National Semiconductor	BCP56
QQ1	Voltage Regulator	Infineon	LM7805
R1, R2, R3	Resistor, 220 ohm, 1/4W	Digi-Key	220QBK
R4	Resistor 1.2 k-ohms	Digi-Key	P1.2KGCT-ND
R5	Resistor 1.3 k-ohms	Digi-Key	P1.3KGCT-ND
R6	Potentiometer 2 k-ohms	Digi-Key	3224W-202ETR-ND
R7	Resistor 24 k-ohms	Digi-Key	P24KECT-ND
R8, R10	Resistor 5.1 k-ohms	Digi-Key	P5.1KECT-ND
R9, R11	Resistor, 10 ohms	Digi-Key	P10ECT-ND

¹Gerber files for this circuit are available on request.

Package Outline Specifications

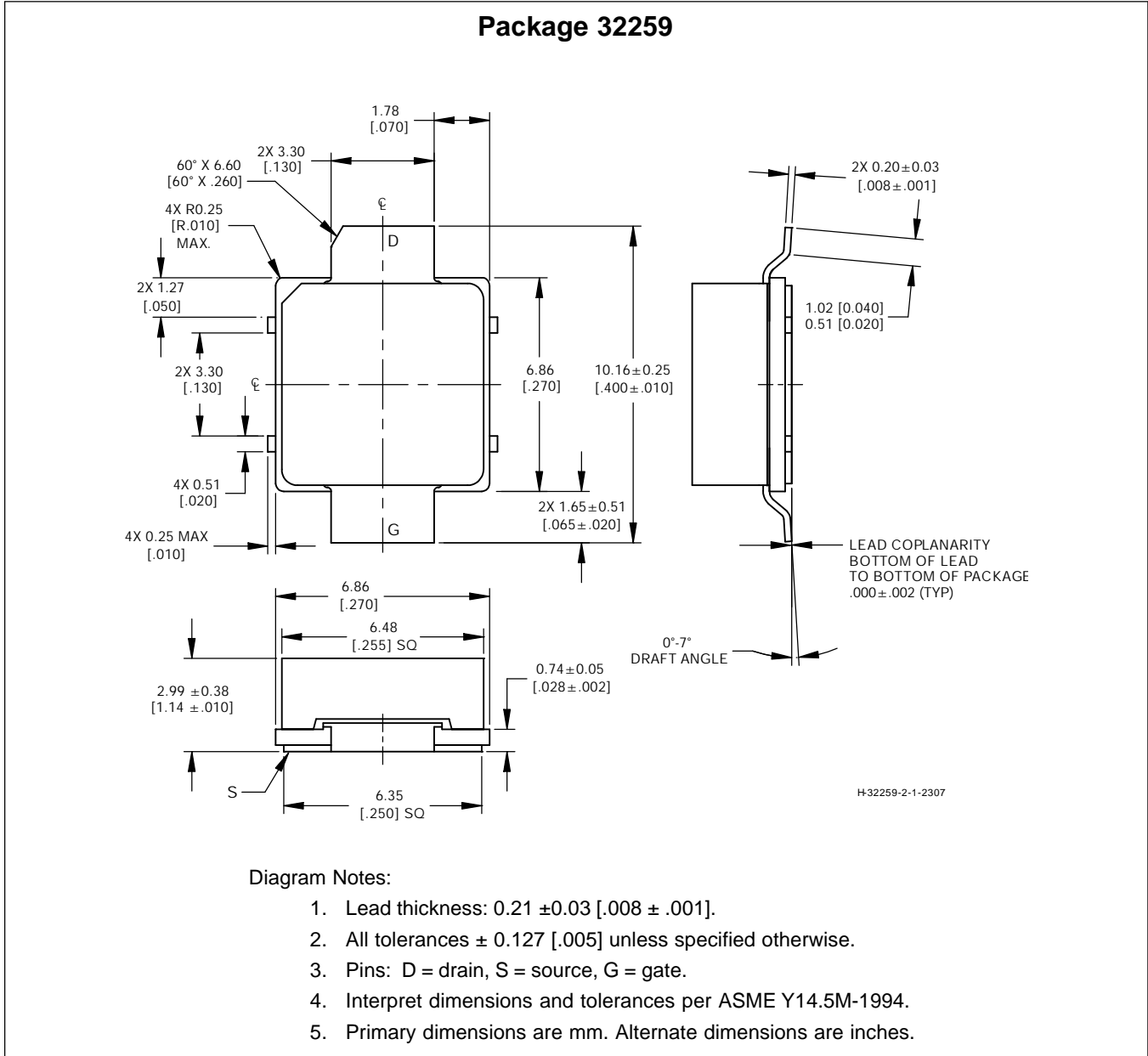

Find the latest and most complete information about products and packaging at the Infineon Internet page <http://www.infineon.com/products>.

Page	Subjects (major changes since last revision)
	Add specification data and information, remove Preliminary Status

We Listen to Your Comments

Any information within this document that you feel is wrong, unclear or missing at all?
 Your feedback will help us to continuously improve the quality of this document.
 Please send your proposal (including a reference to this document) to:

highpowerRF@infineon.com

To request other information, contact us at:
 +1 877 465 3667 (1-877-GOLDMOS) USA
 or +1 408 776 0600 International

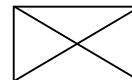

GOLDMOS® is a registered trademark of Infineon Technologies AG.

Edition 2004-10-05

**Published by Infineon Technologies AG,
 St.-Martin-Strasse 53,
 81669 München, Germany**

**© Infineon Technologies AG 2004.
 All Rights Reserved.**

Attention please!

The information herein is given to describe certain components and shall not be considered as a guarantee of characteristics.

Terms of delivery and rights to technical change reserved.

We hereby disclaim any and all warranties, including but not limited to warranties of non-infringement, regarding circuits, descriptions and charts stated herein.

Information

For further information on technology, delivery terms and conditions and prices please contact your nearest Infineon Technologies Office (www.infineon.com/rfpower).

Warnings

Due to technical requirements components may contain dangerous substances. For information on the types in question please contact your nearest Infineon Technologies Office.

Infineon Technologies Components may only be used in life-support devices or systems with the express written approval of Infineon Technologies, if a failure of such components can reasonably be expected to cause the failure of that life-support device or system, or to affect the safety or effectiveness of that device or system. Life support devices or systems are intended to be implanted in the human body, or to support and/or maintain and sustain and/or protect human life. If they fail, it is reasonable to assume that the health of the user or other persons may be endangered.